

E10 RECTO CILINDRICO MACHO

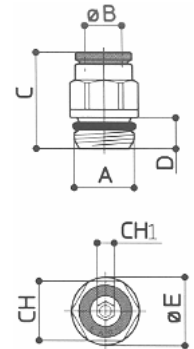

CODIGO	A	B	C	D	E	F	G	CH	CH1	Gr
E105048	M5	4	20	4	10			9	2,5	-
E107148	M7x1	4	21	5	10			9	2,5	-
E108047	1/8	4	17	5	11			10	3	5
E104047	1/4	4	17,5	6	14,3			10	3	9
E105068	M5	6	21	4	11,7			11	2,5	-
E107168	M7x1	6	22	5	11,7			11	3	-
E108067	1/8	6	20	5	11,7			11	4	6
E104067	1/4	6	19	6	14,3			11	4	9
E1010187	M10x1	8	23	5	14,5			13	5	10
E108087	1/8	8	25	5	14,3			13	5	13
E104087	1/4	8	21,5	6	14,3			13	6	11
E103087	3/8	8	21	8	18			13	6	16
E104107	1/4	10	27	6	17			16	7	18
E103107	3/8	10	26	8	18			16	8	21
E102107	1/2	10	25	9	22,5			16	8	30
E104127	1/4	12	30	6	21			19	7	29
E103127	3/8	12	30	8	21			19	9	30
E102127	1/2	12	29,5	9	22			19	10	35



E23 RECTO CILINDRICO HEMBRA



CODIGO	A	B	C	D	E	F	G	CH	CH1	Gr
E238040	1/8	4	25	10	13,5			12		12
E234040	1/4	4	27	12	18			16		19
E238060	1/8	6	26,5	10	13,5			12		13
E234060	1/4	6	28,5	12	18			16		22
E238080	1/8	8	27	10	14,5			13		19
E234080	1/4	8	29	12	18			16		18
E233080	3/8	8	30	13	22,4			20		23
E234100	1/4	10	29,5	12	17			16		26
E233100	3/8	10	30,5	13	21			16		29

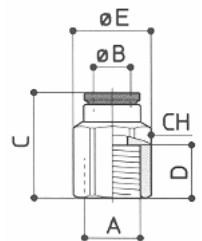

E20 CODO GIRATORIO CILINDRICO MACHO



CODIGO	A	B	C	D	E	F	G	CH	CH1	Gr
E205048	M5	4	15,5	4	16	10	10	9		-
E207148	M7x1	4	16,5	5	16	10	10	9		-
E208047	1/8	4	16	5	16	10	11	10		7
E204047	1/4	4	18	6	16	10	14,3	10		13
E205068	M5	6	16,5	4	18,5	12,6	11,7	11		-
E207168	M7x1	6	17,5	5	18,5	12,6	11,7	11		-
E208067	1/8	6	18	5	18,5	12,6	11,7	11		7
E204067	1/4	6	19	6	18,5	12,6	14,3	11		13
E208087	1/8	8	19,5	5	20,5	14,5	14,3	13		8
E204087	1/4	8	20	6	20,5	14,5	14,3	13		13
E203087	3/8	8	23	8	20,5	18	18	13		26
E204107	1/4	10	23	6	26	16,3	17	16		18
E203107	3/8	10	25,5	8	26	16,3	20	18		24
E202107	1/2	10	27	9	26	16,3	24	22		34
E204127	1/4	12	25,5	6	29,5	19	21	19		35
E203127	3/8	12	27,5	8	29,5	19	21	19		31
E202127	1/2	12	29,5	9	29,5	19	24	22		41

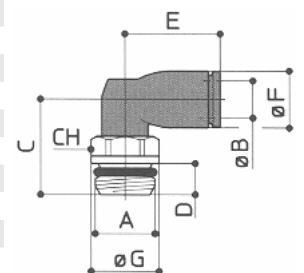

E20L CODO GIRATORIO CILINDRICO MACHO LARGO

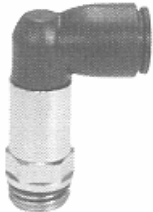

CODIGO	A	B	C	D	E	F	G	CH	CH1	Gr
E20L8047	1/8	4	22,5	5	16	10	11	10	-	-
E20L4047	1/4	4	23,5	6	16	10	14,3	10	-	-
E20L8067	1/8	6	27	5	18,5	12,6	11,7	11	-	-
E20L4067	1/4	6	27	6	18,5	12,6	14,3	11	-	-
E20L8087	1/8	8	30,5	5	20,5	14,5	14,3	13	-	-
E20L4087	1/4	8	30	6	20,5	14,5	14,3	13	-	-
E20L3087	3/8	8	31	8	20,5	14,5	18	13	-	-

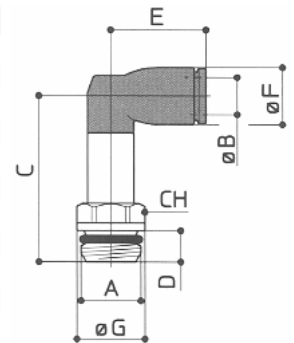

E14 CODO GIRATORIO CILINDRICO MACHO CON LLAVE ALLEN



CODIGO	A	B	C	D	E	F	G	CH	CH1	Gr
E145048	M5	4	13,5	4	18,5	9,5	9,8	2,5	4	4
E148047	1/8	4	14	5	18	19	14,3	4	11	11
E144047	1/4	4	15,5	6	18,5	19	14,3	4	14	14
E148067	1/8	6	14	5	18	20	14,3	4	11	11
E144067	1/4	6	15,5	6	18,5	20	14,3	4	14	14
E148087	1/8	8	14	5	18	21	14,3	4	11	11
E144087	1/4	8	15,5	6	18,5	21	14,3	4	15	15

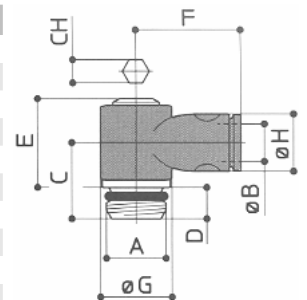

E14L CODO GIRATORIO CILINDRICO MACHO CON LLAVE ALLEN LARGO

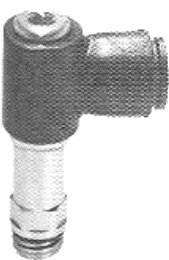

CODIGO	A	B	C	D	E	F	G	CH	CH1	Gr
E14L8047	1/8	4	30,5	5	19	14,3	10,3	4	10	17
E14L4047	1/4	4	32	6	19	14,3	10,3	4	10	21
E14L8067	1/8	6	30,5	5	20	14,3	12,6	4	10	17
E14L4067	1/4	6	32	6	20	14,3	12,6	4	10	21
E14L8087	1/8	8	30,5	5	21	14,3	14,5	4	10	18
E14L4087	1/4	8	32	6	21	14,3	14,5	4	10	22

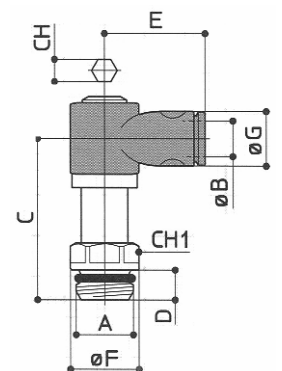

E22 CODO GIRATORIO CILINDRICO HEMBRA

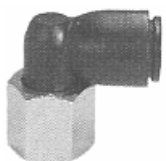

CODIGO	A	B	C	D	E	F	G	CH	CH1	Gr
E228040	1/8	4	18	10	16	10	13,5	12	8	8
E224040	1/4	4	20	12	16	10	18	16	14	14
E228060	1/8	6	19	10	18,5	12,6	13,5	12	9	9
E224060	1/4	6	21	12	18,5	12,6	18	16	15	15
E228080	1/8	8	20	10	20,5	14,5	14,5	13	11	11
E224080	1/4	8	22	12	20,5	14,5	18	16	16	16
E223080	3/8	8	23	13	20,5	14,5	22,4	20	21	21
E224100	1/4	10	25	12	26	16,3	17	16	25	25
E223100	3/8	10	26	13	26	16,3	21	19	30	30

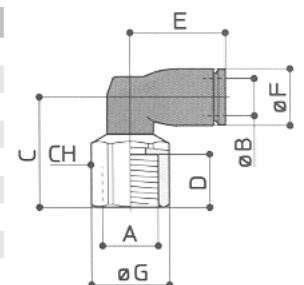

E33 T LATERAL GIRATORIA CILINDRICA MACHO



CODIGO	A	B	C	D	E	F	G	CH	CH1	Gr
E335048	M5	4	15,5	4	16	10	10	9		4
E337148	M7x1	4	16,5	5	16	10	10	9		4
E338047	1/8	4	16	5	16	10	11	10		7
E334047	1/4	4	18	6	16	10	14,3	10		14
E335068	M5	6	16,5	4	18,5	12,6	11,7	11		7
E337168	M7x1	6	17,5	5	18,5	12,6	11,7	11		7
E338067	1/8	6	18	5	18,5	12,6	11,7	11		10
E334067	1/4	6	19	6	18,5	12,6	14,3	11		13
E338087	1/8	8	19,5	5	20,5	14,5	14,3	13		11
E334087	1/4	8	20	6	20,5	14,5	14,3	13		16
E333087	3/8	8	23	8	20,5	14,5	18	13		28
E334107	1/4	10	23	6	26	16,3	17	16		22
E333107	3/8	10	25,5	8	26	16,3	20	18		28
E332107	1/2	10	27	9	26	16,3	24	22		39
E334127	1/4	12	25,5	6	29,5	19	21	19		35
E333127	3/8	12	27,5	8	29,5	19	21	19		40
E332127	1/2	12	29,5	9	29,5	19	24	22		50

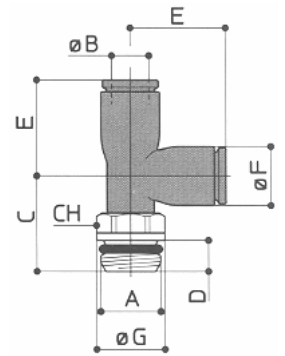

E40 T CENTRAL GIRATORIA CILINDRICA MACHO



CODIGO	A	B	C	D	E	F	G	CH	CH1	Gr
E405048	M5	4	15,5	4	16	10	10	9		4
E407148	M7x1	4	16,5	5	16	10	10	9		4
E408047	1/8	4	16	5	16	10	11	10		8
E404047	1/4	4	18	6	16	10	14,3	10		14
E405068	M5	6	16,5	4	18,5	12,6	11,7	11		7
E407168	M7x1	6	17,5	5	18,5	12,6	11,7	11		7
E408067	1/8	6	18	5	18,5	12,6	11,7	11		9
E404067	1/4	6	19	6	18,5	12,6	14,3	11		15
E408087	1/8	8	19,5	5	20,5	14,5	14,3	13		11
E404087	1/4	8	20	6	20,5	14,5	14,3	13		16
E403087	3/8	8	23	8	20,5	14,5	18	13		29
E404107	1/4	10	23	6	26	16,3	17	16		22
E403107	3/8	10	25,5	8	26	16,3	20	18		28
E402107	1/2	10	27	9	26	16,3	24	22		39
E404127	1/4	12	25,5	6	29,5	19	21	19		34
E403127	3/8	12	27,5	8	29,5	19	21	19		39
E402127	1/2	12	29,5	9	29,5	19	24	22		50

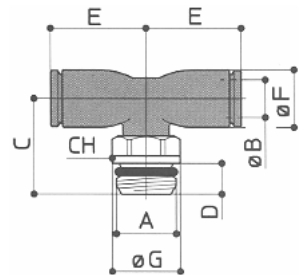

E41 T CENTRAL GIRATORIA CILINDRICA HEMBRA

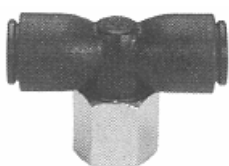

CODIGO	A	B	C	D	E	F	G	CH	CH1	Gr
E418040	1/8	4	18	10	16	10	13,5	12		10
E414040	1/4	4	20	12	16	10	18	16		15
E418060	1/8	6	19	10	18,5	12,6	13,5	12		11
E414060	1/4	6	21	12	18,5	12,6	18	16		17
E418080	1/8	8	20	10	20,5	14,5	14,5	13		13
E414080	1/4	8	22	12	20,5	14,5	18	16		19
E413080	3/8	8	23	13	20,5	14,5	22,4	20		24
E414100	1/4	10	25	12	26	16,3	17	16		28
E413100	3/8	10	26	13	26	16,3	21	19		30

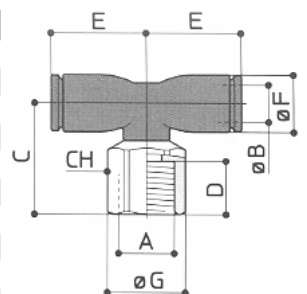

E50 PROLONGADOR



CODIGO	A	B	C	D	E	F	G	CH	CH1	Gr
E500040	4	11	31							3
E500060	6	14	36							4
E500080	8	16	37							5
E500100	10	16,3	39							11
E500120	12	19	45							14

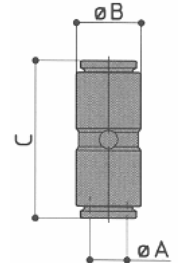

E60 CODO INTERMEDIO



CODIGO	A	B	C	D	E	F	G	CH	CH1	Gr
E600040	4	10	17							2
E600060	6	13,5	21							3
E600080	8	15,5	22,5							5
E600100	10	16,3	26							12
E600120	12	19	29,5							16

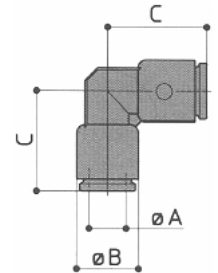

E70 T INTERMEDIA

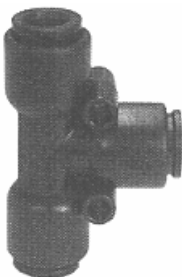

CODIGO	A	B	C	D	E	F	G	CH	CH1	Gr
E700040	4	10	17	12	6	2,5				3
E700060	6	13,5	21	16	8	3				5
E700080	8	15,5	22,5	18	9	3				7
E700100	10	16,3	26	20	10	4,2				15
E700120	12	19	29,5	22	11	4,2				19

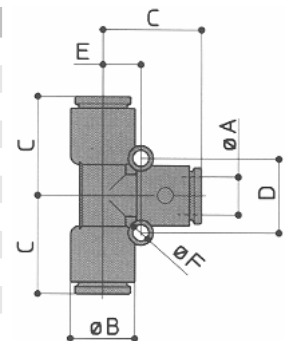

E26 CRUZ GIRATORIA INTERMEDIA

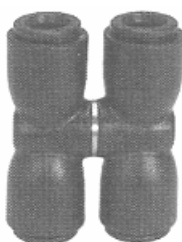

CODIGO	A	B	C	C1	D	E	E1	Gr
E260040	4	4	16	16	13	10	10	6
E260060	6	6	18,5	18,5	15	12,6	12,6	9
E260080	8	8	20,5	20,5	17	14,5	14,5	14
E260100	10	10	26	26	22	16	16	27
E266040	6	4	18,5	16	14	12,6	10	8
E268040	8	4	20,5	16	15	14,5	10	10
E268060	8	6	20,5	18,5	16	14,5	12,6	16
E261060	10	6	26	18,5	18	16,3	12,6	18
E261080	10	8	26	20,5	19	16,3	14,5	20

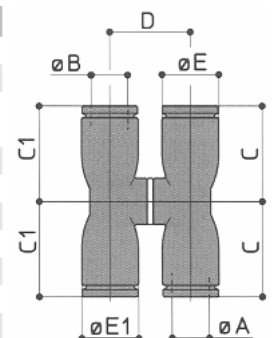

E75 T INTERMEDIA CENTRAL GIRATORIA

CODIGO	A	B	C	C1	D	E	E1	Gr
E750040	4	4	16	16	13	10	10	7
E750060	6	6	18,5	18,5	15	12,6	12,6	8
E750080	8	8	20,5	20,5	17	14,5	14,5	12
E750100	10	10	26	26	22	16,3	16,3	22
E756040	6	4	18,5	16	14	12,6	10	8
E758040	8	4	20,5	16	15	14,5	10	9
E758060	8	6	20,5	18,5	16	14,5	12,6	10
E751060	10	6	26	18,5	18	16,3	12,6	17
E751080	10	8	26	20,5	19	16,3	14,5	19
E754060	4	6	16	18,5	14	10	12,6	8
E754080	4	8	16	20,5	15	10	14,5	9
E756080	6	8	18,5	20,5	16	12,6	14,5	10
E756100	6	10	18,5	26	18	12,6	16,3	16
E758100	8	10	20,5	26	19	14,5	16,3	18

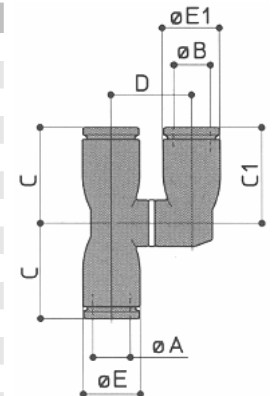
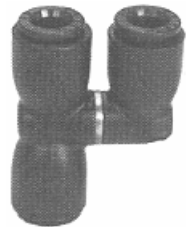

E91 T INTERMEDIA LATERAL GIRATORIA

CODIGO	A	B	C	D	E	F	G	CH	CH1	Gr
E910040	4	4	16	16	13	10	10			5
E910060	6	6	18,5	18,5	15	12,6	12,6			7
E910080	8	8	20,5	20,5	17	14,5	14,5			11
E910100	10	10	26	26	22	16,3	16,3			21
E916040	6	4	18,5	16	14	12,6	10			6
E918040	8	4	20,5	16	15	14,5	10			9
E918060	8	6	20,5	18,5	16	14,5	12,6			10
E911060	10	6	26	18,5	18	16,3	12,6			15
E911080	10	8	26	20,5	19	16,3	14,5			17
E914060	4	6	16	18,5	14	10	12,6			6
E914080	4	8	16	20,5	15	10	14,5			9
E916080	6	8	18,5	20,5	16	12,6	14,5			10
E916100	6	10	18,5	26	18	12,6	16,3			15
E918100	8	10	20,5	26	19	14,5	16,3			17

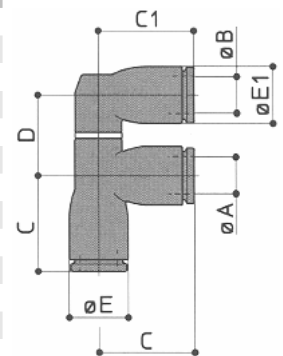

E92 DOBLE T INTERMEDIA LATERAL GIRATORIA

CODIGO	A	B	C	D	E	F	G	CH	CH1	Gr
E920040	4	4	16	16	13	10	10			6
E920060	6	6	18,5	18,5	15	12,6	12,6			9
E920080	8	8	20,5	20,5	17	14,5	14,5			13
E920100	10	10	26	26	22	16,3	16,3			26
E926040	6	4	18,5	16	14	12,6	10			7
E928040	8	4	20,5	16	15	14,5	10			10
E928060	8	6	20,5	18,5	16	14,5	12,6			11
E921060	10	6	26	18,5	18	16,3	12,6			17
E921080	10	8	26	20,5	19	16,3	14,5			19

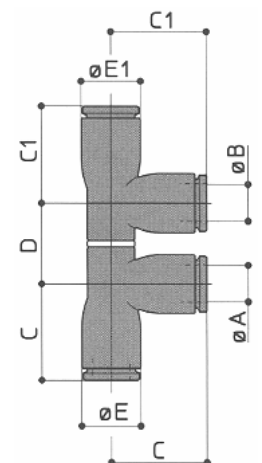
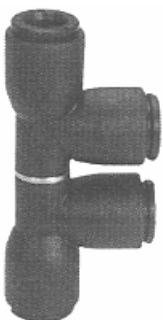

E59 ADAPTADOR RECTO CILINDRICO MACHO

CODIGO	A	B	C	D	E	F	G	CH	CH1	Gr
E598047	1/8	4	26	5	16	11		10		-
E598067	1/8	6	30,5	5	20	11		10		-
E594067	1/4	6	31,5	6	20	14,3		10		-
E598087	1/8	8	37	5	22	11		10		-
E594087	1/4	8	38	6	22	14,3		10		-
E593087	3/8	8	40	8	22	18		10		-

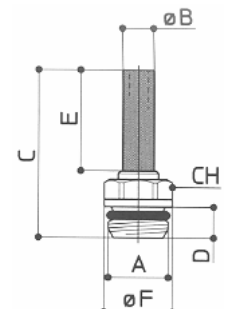

E54 ACOPLAMIENTO TUBO EN CODO



CODIGO	A	B	C	D	E	F	G	CH	CH1	Gr
E544040	4	4	16	16	22	10				2
E546060	6	6	18,5	20	27	12,6				2
E548080	8	8	20,5	22	30	14,5				3

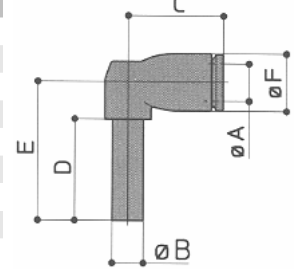

E57 ACOPLAMIENTO TUBO EN T CENTRAL

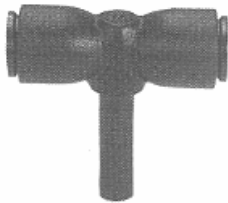

CODIGO	A	B	C	D	E	F	G	CH	CH1	Gr
E570440	4	4	16	16	22	10				2
E570660	6	6	18,5	20	27	12,6				2
E570880	8	8	20,5	22	30	14,5				3

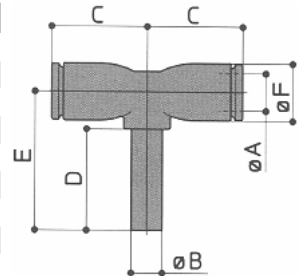

E58 ACOPLAMIENTO TUBO EN T LATERAL



CODIGO	A	B	C	D	E	F	G	CH	CH1	Gr
E580440	4	4	16	16	22	10				3
E580660	6	6	18,5	20	27	12,6				4
E580880	8	8	20,5	22	30	14,5				5

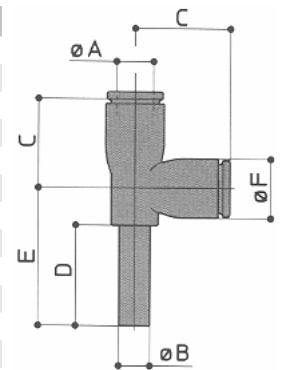

E24 PROLONGADOR REDUCTOR



CODIGO	A	B	C	D	E	F	G	CH	CH1	Gr
E244060	4	6	35	14						3
E244080	4	8	36	16						4
E246080	6	8	37	16						4

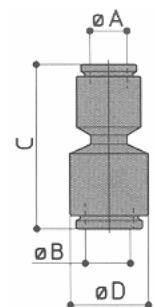

E25 ACOPLAMIENTO TUBO - TUBO



CODIGO	A	B	C	D	E	F	G	CH	CH1	Gr
E254060	4	6	44	11	22					3
E254080	4	8	46	14	25					4
E256080	6	8	48	14	25					4

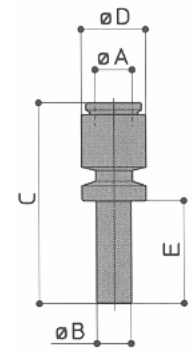

35 TORNILLO SIMPLE



CODIGO	A	B	C	D	E	F	G	CH	CH1	Gr
3580SR	1/8	27						14		13
3540SR	1/4	29,5						17		22

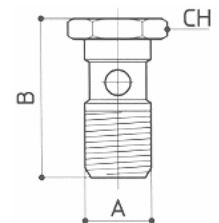

35 TORNILLO SIMPLE HEMBRA



CODIGO	A	B	C	D	E	F	G	CH	CH1	Gr
3588SR	1/8	35						14		18
3544SR	1/4	40						17		31

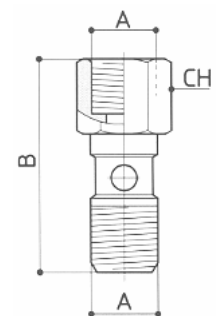

36 TORNILLO DOBLE



CODIGO	A	B	C	D	E	F	G	CH	CH1	Gr
3680SR	1/8	43						14		18
3640SR	1/4	46						17		32

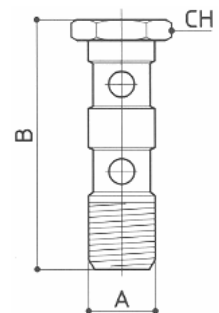

37 TORNILLO TRIPLE



CODIGO	A	B	C	D	E	F	G	CH	CH1	Gr
3780SR	1/8	58,5						14		24
3740SR	1/4	64						17		41

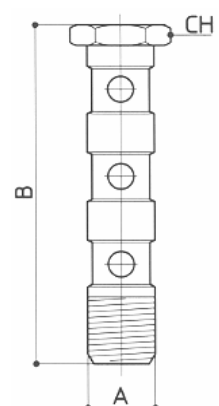

E38 ORIENTABLE SIMPLE



CODIGO	A	B	C	D	E	F	G	CH	CH1	Gr
E385040	5,2-M5	4	10,5	18,5	9,5	9,8	4			2
E388040	9,9-1/8	4	15,5	19	14,3	10,3	6			4
E384040	13,1-1/4	4	17,5	20,5	17,3	10,3	7,5			3
E388060	9,9-1/8	6	15,5	20	14,3	12,6	6			4
E384060	13,1-1/4	6	17,5	21,5	17,3	12,6	7,5			3
E388080	9,9-1/8	8	15,5	21	14,3	14,5	6			4
E384080	13,1-1/4	8	17,5	22,5	17,3	14,5	7,5			4

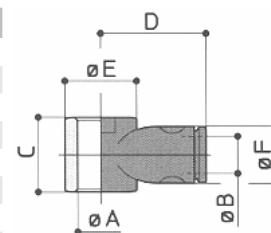

EDRN REGULADOR DE VELOCIDAD



CODIGO	A	B	C	D	E	E1	E2	E3	F	G	H	CH	Gr
Ei5048	M5	4	11,3	4	21,5	22	28	31,5	19,4	9,5	9,8	6	-
Ei8047	1/8	4	16	5	24,5	28	41	47	19	14,3	10,3	8	14
Ei8067	1/8	6	16	5	24,5	28	41	47	20	14,3	12,6	8	15
Ei4067	1/4	6	18,5	6	28	32	45	51,5	21,5	17,3	12,6	10	27
Ei8087	1/8	8	16	5	24,5	28	41	47	21	14,3	14,5	8	15
Ei4087	1/4	8	18,5	6	28	32	45	51,5	22,5	17,3	14,5	10	28



D REGULADOR PARA CILINDRO

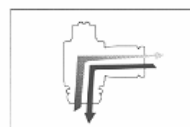

ED



R REGULADOR PARA VALVULA



ER



N REGULADOR BIDIRECCIONAL



EN

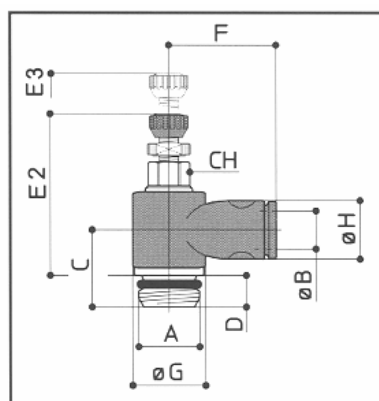
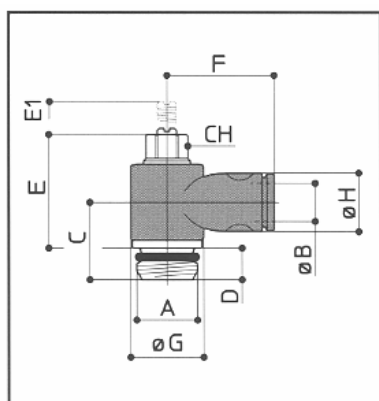

PARA PEDIR EL REGULADOR CON EL POMO MONTADO, FINALIZAR EL CODIGO DEL ARTICULO CON:

TO ORDER FLOW REGULATORS FITTED WITH THE HANDWHEEL, COMPLETE THE ITEM CODE AS FOLLOWS:
POUR COMMANDER DES DOSEURS EQUIPES DE VOLANT A MAIN, IL FAUT FAIRE SUIVRE LE CODE DU PRODUIT DE:
FÜR DIE BESTELLUNG VON DROSSELN MIT EINGEBAUTEM HANDRAD, DEN ARTIKELCODE FOLGENDERMASSEN BEENDEN:

EJEMPLO - - EXEMPLE - BEISPIEL:

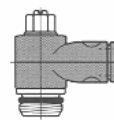

EN8047

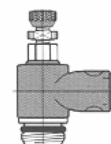

EN8047V

V

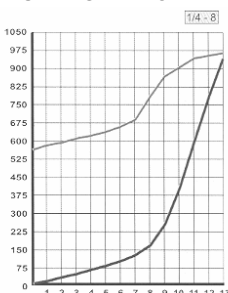
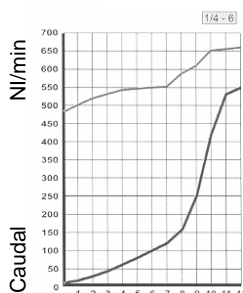
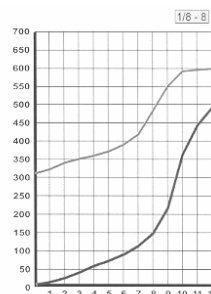
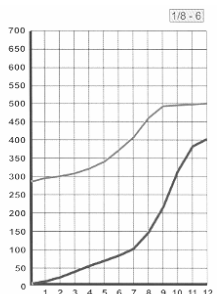
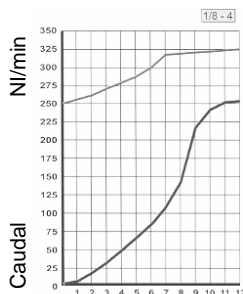

RETORNO
REGULACION

CAUDAL A 6 BAR